

Three-phase monitoring relays CM-PAS

CM-PAS.31 and CM-PAS.41

The three-phase monitoring relays CM-PAS.x1 monitor the phase parameters phase sequence, phase failure as well as phase unbalance.

All devices are available with two different terminal versions. You can choose between the proven screw connection technology (double-chamber cage connection terminals) and the completely tool-free Easy Connect Technology (push-in terminals).



2CDC 251 063 V0011

Characteristics

- Monitoring of three-phase mains for phase sequence, phase failure, phase unbalance
- TRMS measuring principle
- Threshold value for phase unbalance is adjustable as absolute value
- Tripping delay T_v adjustable or switched off by means of a logarithmic scale (0 s; 0,1-30 s)
- ON-delayed tripping delay
- Powered by the measuring circuit
- Precise adjustment by front-face operating controls
- Screw connection technology or Easy Connect Technology available
- Housing material for highest fire protection classification UL 94 V-0
- Tool-free mounting on DIN rail as well as demounting
- 2 c/o (SPDT) contacts
- 22.5 mm (0.89 in) width
- 3 LEDs for the indication of operational states

Approvals

- UL 508, CAN/CSA C22.2 No.14
- GL
- GOST
- CB scheme
- CCC
- RMRS

pending

Marks

- CE
- C-Tick

Order data

Three-phase monitoring relays

Type	Rated control supply voltage = measuring voltage	Connection technology	Order code
CM-PAS.31P	3 x 160-300 V AC	Push-in terminals	1SVR 740 774 R1300
CM-PAS.31S		Screw terminals	1SVR 730 774 R1300
CM-PAS.41P	3 x 300-500 V AC	Push-in terminals	1SVR 740 774 R3300
CM-PAS.41S		Screw terminals	1SVR 730 774 R3300

Accessories

Type	Description	Order code
ADP.01	Adapter for screw mounting	1SVR 430 029 R0100
MAR.01	Marker label for devices without DIP switches	1SVR 366 017 R0100
COV.11	Sealable transparent cover	1SVR 730 005 R0100

Connection technology

Maintenance free Easy Connect Technology with push-in terminals

Type designation CM-xxS.yyP

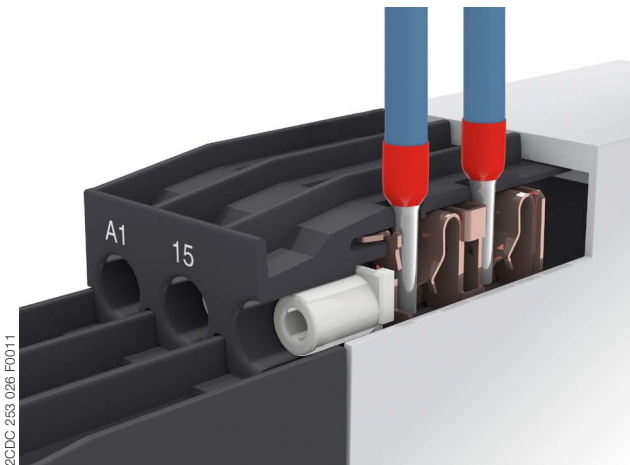

Push-in terminals

- Tool-free connection of rigid and flexible wires with wire end ferrule according to DIN 46228-1-A, DIN 46228-4-E
Wire size: 2 x 0.5-1.5 mm², (2 x 20 - 16 AWG)
- Easy connection of flexible wires without wire end ferrule by opening the terminals
- No retightening necessary
- One operation lever for opening both connection terminals
- For triggering the lever and disconnecting of wires you can use the same tool (Screwdriver according to DIN ISO 2380-1 Form A 0.8 x 4 mm (0.0315 x 0.157 in), DIN ISO 8764-1 PZ1 ø 4.5 mm (0.177 in))
- Constant spring force on terminal point independent of the applied wire type, wire size or ambient conditions (e. g. vibrations or temperature changes)
- Opening for testing the electrical contacting
- Gas-tight

Approved screw connection technology with double-chamber cage connection terminals

Type designation CM-xxS.yyS

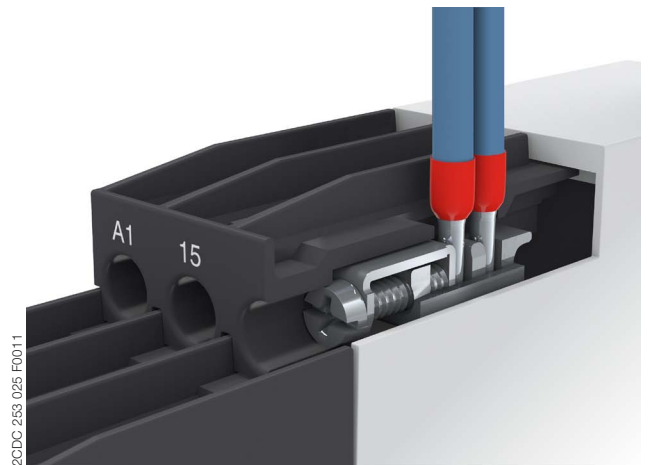

Double-chamber cage connection terminals

- Terminal spaces for different wire sizes:
fine-strand with/without wire end ferrule:
1 x 0.5-2.5 mm² (2 x 20 - 14 AWG),
2 x 0.5-1.5 mm² (2 x 20 - 16 AWG)
rigid:
1 x 0.5-4 mm² (1 x 20 - 12 AWG),
2 x 0.5-2.5 mm² (2 x 20 - 14 AWG)
- One screw for opening and closing of both cages
- Pozidrive screws for pan- or crosshead screwdrivers according to DIN ISO 2380-1 Form A 0.8 x 4 mm (0.0315 x 0.157 in), DIN ISO 8764-1 PZ1 ø 4.5 mm (0.177 in)

Both the Easy Connect Technology with push-in terminals and screw connection technology with double-chamber cage connection terminals have the same connection geometry as well as terminal position.

Functions

Operating controls

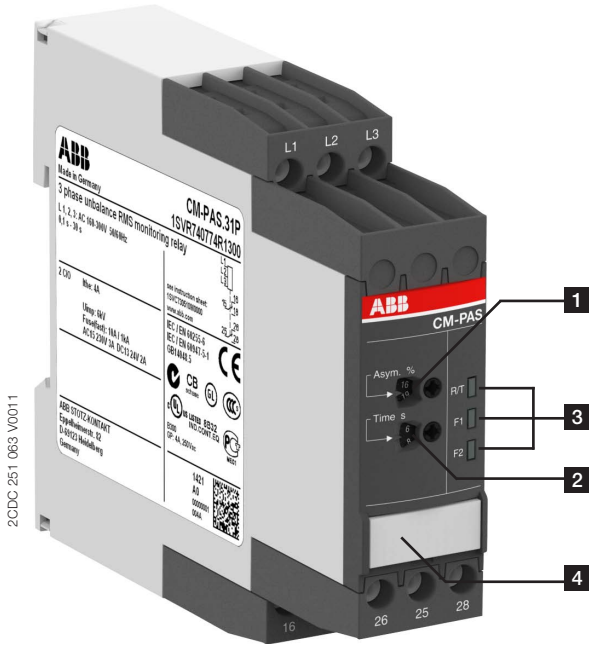

- 1** Adjustment of the threshold value Asym. for phase unbalance
- 2** Adjustment of the tripping delay T_v
- 3** Indication of operational states
 - R/T: red LED – Relay status / timing
 - F1: yellow LED – Fault message
 - F2: yellow LED – Fault message
- 4** Marker label

Application

The three-phase monitoring relays CM-PAS.x1 are designed for use in three-phase mains for monitoring the phase parameters phase sequence, phase failure as well as phase unbalance.

The CM-PAS.x1 provide an adjustable ON-delay and work according to the closed-circuit principle.

Operating mode

The CM-PAS.x1 have 2 c/o (SPDT) contacts and are available for 3-wire AC systems. The units are adjusted with front-face operating controls. Potentiometers, with direct reading scale, allow the adjustment of the threshold value for phase unbalance (Asym %) and the tripping delay T_v . The tripping delay T_v is adjustable over a range of instantaneous to a 30 s delay. Timing is displayed by a flashing yellow LED labelled R/T.

Adjustment potentiometer

Threshold values

By means of three separate potentiometers with direct reading scales, the threshold values for over- and undervoltage as well as for phase unbalance can be adjusted within the measuring range.

	Measuring range for phase unbalance
CM-PAS.31	2-25 % of average of phase voltages
CM-PAS.41	

Tripping delay T_v

The tripping delay T_v can be adjusted within a range of 0.1 to 30 s by means of a potentiometer with logarithmic scale. By turning to the left stop, the tripping delay can be switched off.

Indication of operational states

LEDs, status information and fault messages

Operational state	R/T: LED yellow	F1: LED red	F2: LED red
Control supply voltage applied, output relay energized		-	-
Tripping delay T_v active		-	-
Phase failure	-		
Phase sequence	-	alternating	
Phase unbalance	-		

Function descriptions / diagrams

Phase sequence and phase failure monitoring

Applying control supply voltage begins the fixed start-up delay T_s . When T_s is complete and all phases are present with correct voltage, the output relays energize and the yellow LED R/T is on.

Phase sequence monitoring:

The output relays de-energize as soon as a phase sequence error occurs. The fault is displayed by alternated flashing of the LEDs F1 and F2. The output relays re-energize automatically as soon as the phase sequence is correct again.

Phase failure monitoring:

The output relays de-energize instantaneously if a phase failure occurs. The fault is indicated by lightning of LED F1 and flashing of LED F2. The output relays re-energize automatically as soon as the voltage returns to the tolerance range.

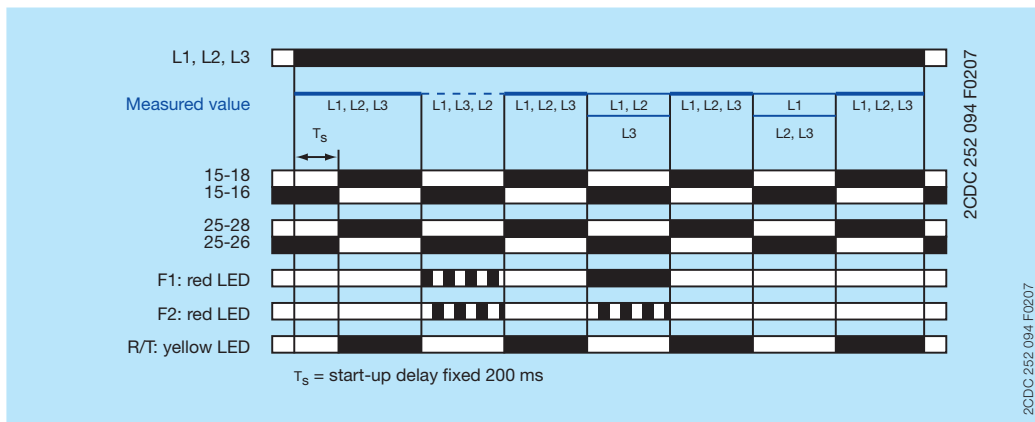

Phase unbalance monitoring

Applying control supply voltage begins the fixed start-up delay T_s . When T_s is complete and all phases are present with correct voltage and with correct phase sequence, the output relays energize and the yellow LED R/T is on.

If the voltage to be monitored exceeds or falls below the set phase unbalance threshold value, the output relays de-energize after the set tripping delay T_v is complete. The LED R/T flashes during timing and turns off as soon as the output relays de-energize.

The output relays re-energize automatically as soon as the voltage returns to the tolerance range, taking into account a fixed hysteresis of 20 %. The LED R/T is on.

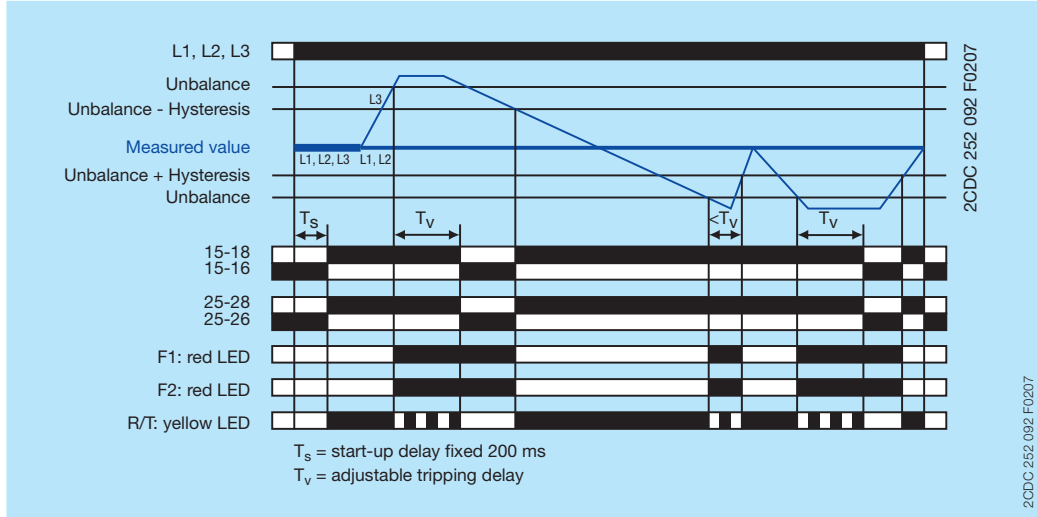

Electrical connection

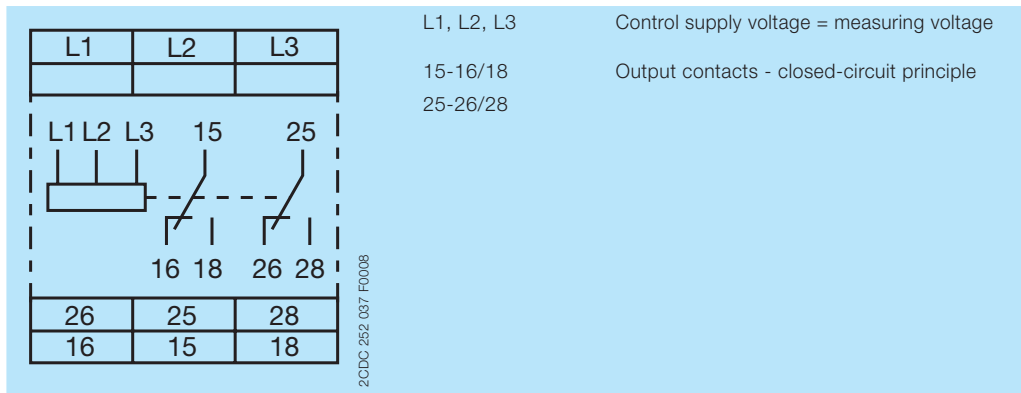

Connection diagram CM-PAS.31 and CM-PAS.41

Technical data

Data at $T_a = 25\text{ °C}$ and rated values, unless otherwise indicated

Input circuit

Type		CM-PAS.31	CM-PAS.41
Supply circuit = measuring circuit		L1, L2, L3	
Rated control supply voltage U_s = measuring voltage		3 x 160-300 V AC	3 x 300-500 V AC
Rated control supply voltage U_s tolerance		-15...+10 %	
Rated frequency		50/60 Hz	
Frequency range		45-65 Hz	
Typical current / power consumption		25 mA / 10 VA (230 V AC)	25 mA / 18 VA (400 V AC)
Measuring circuit		L1, L2, L3	
Monitoring functions	Phase failure	■	■
	Phase sequence	■	■
	Phase unbalance	■	■
Measuring range	Phase unbalance	2-25 % of average of phase voltages	
Thresholds	Phase unbalance (switch-off value)	adjustable within measuring range	
Hysteresis related to the threshold value	Phase unbalance	fixed 20 %	
Rated frequency of the measuring signal		50/60 Hz	
Frequency range of the measuring signal		45-65 Hz	
Maximum measuring cycle time		100 ms	
Accuracy within the rated control supply voltage tolerance		$\Delta U \leq 0.5\%$	
Accuracy within the temperature range		$\Delta U \leq 0.06\% / \text{°C}$	
Measuring method		True RMS	
Timing circuit			
Start-up delay T_s		fixed 200 ms	
Tripping delay T_v		ON-delay 0 s; 0.1-30 s adjustable	
Repeat accuracy (constant parameters)		< $\pm 0.2\%$	
Accuracy within the rated control supply voltage tolerance		$\Delta t \leq 0.5\%$	
Accuracy within the temperature range		$\Delta t \leq 0.06\% / \text{°C}$	

User interface

Indication of operational states		
Relay status / timing	R/T	yellow LED
Fault message	F1	red LED
Fault message	F2	red LED

Details see table 'LEDs, status information and fault messages' on page 5 and 'Function descriptions / diagrams' on page 5.

Output circuits

Kind of output	15-16/18	relay, 1st c/o (SPDT) contact
	25-26/28	relay, 2nd c/o (SPDT) contact
		1 x 2 (SPDT) contacts
Operating principle		closed-circuit principle ¹⁾
Contact material		AgNi alloy, Cd free
Rated operational voltage U_0 (IEC/EN 60947-1)		250 V
Minimum switching voltage / Minimum switching current		24 V / 10 mA
Maximum switching voltage / Maximum switching current		see load limit curves
Rated operational current I_e (IEC/EN 60947-5-1)	AC12 (resistive) at 230 V	4 A
	AC15 (inductive) at 230 V	3 A
	DC12 (resistive) at 24 V	4 A
	DC13 (inductive) at 24 V	2 A
AC rating (UL 508)	Utilization category (Control Circuit Rating Code)	B 300
	max. rated operational voltage	300 V AC
	max. continuous thermal current at B 300	5 A
	max. making/breaking apparent power at B 300	3600/360 VA
Mechanical lifetime		30 x 10 ⁶ switching cycles
Electrical lifetime	AC12, 230 V, 4 A	0.1 x 10 ⁶ switching cycles
Maximum fuse rating to achieve	n/c contact	6 A fast-acting
short-circuit protection	n/o contact	10 A fast-acting

General data

MTBF		on request	
Duty time		100 %	
Dimensions (W x H x D)	product dimensions	22.5 x 85.6 x 103.7 mm (0.89 x 3.37 x 4.08 in)	
	packaging dimensions	97 x 109 x 30 mm (3.82 x 4.29 x 1.18 in)	
Weight	net weight	CM-PAS.31	0.133 kg (0.293 lb)
		CM-PAS.41	0.132 kg (0.291 lb)
	gross weight	CM-PAS.31	0.158 kg (0.348 lb)
		CM-PAS.41	0.157 kg (0.346 lb)
Mounting		DIN rail (IEC/EN 60715), snap-on mounting without any tool	
Mounting position		any	
Minimum distance to other units	horizontal	CM-PAS.31	10 mm (0.39 in) in case of continuous voltage of ...
		CM-PAS.41	> 220 V
Material of housing		UL 94 V-0	
Degree of protection	housing	IP50	
	terminals	IP20	

¹⁾ Closed-circuit principle: Output relay(s) de-energize(s) if measured value exceeds or falls below the adjusted threshold value.

Electrical connection

		Screw connection technology	Easy Connect Technology (push-in)
Wire size	fine-strand with(out) wire end ferrule	1 x 0.5-2.5 mm ² (1 x 20-14 AWG) 2 x 0.5-1.5 mm ² (2 x 20-16 AWG)	2 x 0.5-1.5 mm ² (2 x 20-16 AWG)
	rigid	1 x 0.5-4 mm ² (1 x 20-12 AWG) 2 x 0.5-2.5 mm ² (2 x 20-14 AWG)	2 x 0.5-1.5 mm ² (2 x 20-16 AWG)
Stripping length		8 mm (0.32 in)	
Tightening torque		0.6 - 0.8 Nm (5.31 - 7.08 lb.in)	-

Environmental data

Ambient temperature ranges	operation	-25...+60 °C
	storage	-40...+85 °C
Damp heat, cyclic (IEC/EN 60068-2-30)		55 °C, 6 cycles
Climatic category		3K3
Vibration, sinusoidal (IEC/EN 60255-21-1)		Class 2
Shock (IEC/EN 60255-21-2)		Class 2

Isolation data

Type	
Rated insulation voltage U _i	input circuit / output circuit output circuit 1 / output circuit 2
Rated impulse withstand voltage U _{imp} (IEC/EN 60664)	input circuit output circuit
Test voltage between all isolated circuits (routine test)	
Basic insulation	input circuit / output circuit
Protective separation (IEC/EN 61140, EN 50178)	input circuit / output circuit
Pollution degree (IEC/EN 60664, IEC/EN 60255-5)	
Overvoltage category (IEC/EN 60664, IEC/EN 60255-5)	

Standards

Product standard	IEC/EN 60255-6, EN 50178
Low Voltage Directive	2006/95/EC
EMC directive	2004/108/EC
RoHS directive	2002/95/EC

Electromagnetic compatibility

Type		
Interference immunity to		IEC/EN 61000-6-1, IEC/EN 61000-6-2
electrostatic discharge	IEC/EN 61000-4-2	Level 3 (6 kV / 8 kV)
radiated, radio-frequency, electromagnetic field	IEC/EN 61000-4-3	Level 3 (10 V/m)
electrical fast transient / burst	IEC/EN 61000-4-4	Level 3 (2 kV / 2 kHz)
surge	IEC/EN 61000-4-5	Level 4 (2 kV L-L)
conducted disturbances, induced by radio-frequency fields	IEC/EN 61000-4-6	Level 3 (10 V)
harmonics and interharmonics	IEC/EN 61000-4-13	Class 3
Interference emission		IEC/EN 61000-6-3, IEC/EN 61000-6-4
high-frequency radiated	IEC/CISPR 22, EN 55022	Class B
high-frequency conducted	IEC/CISPR 22, EN 55022	Class B

Technical diagrams

Load limit curves

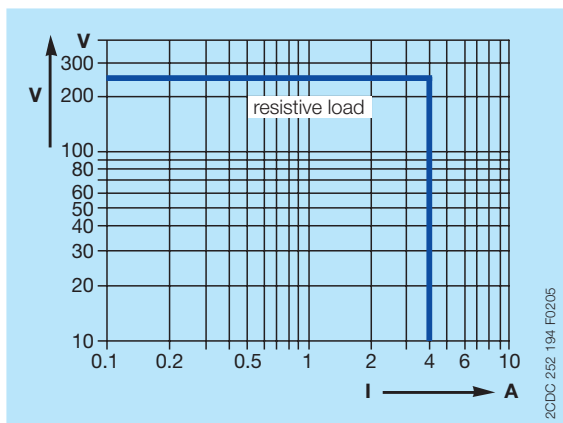

AC load (resistive)

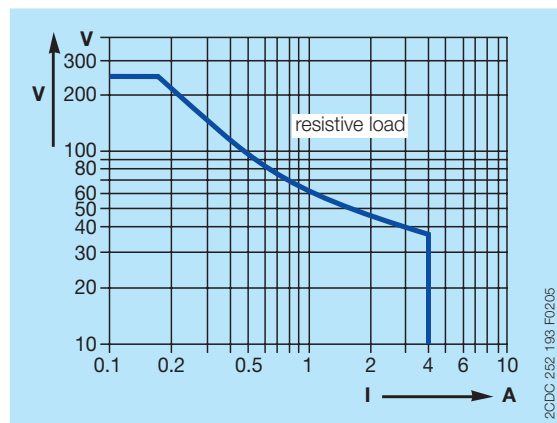

DC load (resistive)

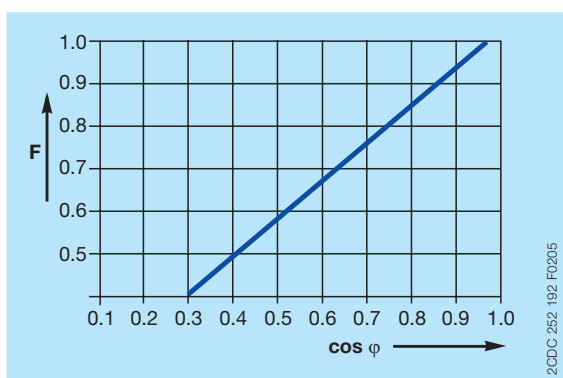

Derating factor F for inductive AC load

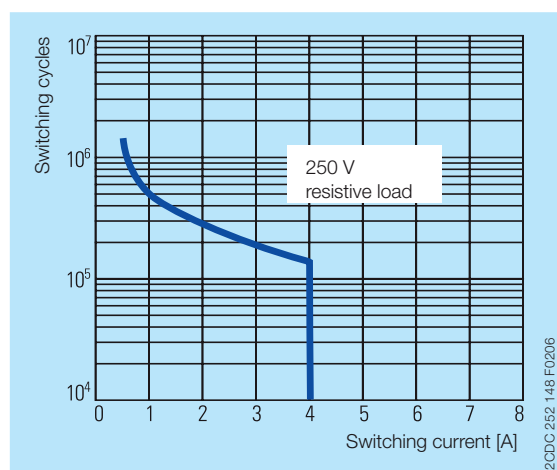

Contact lifetime

Dimensions

in **mm** and *inches*

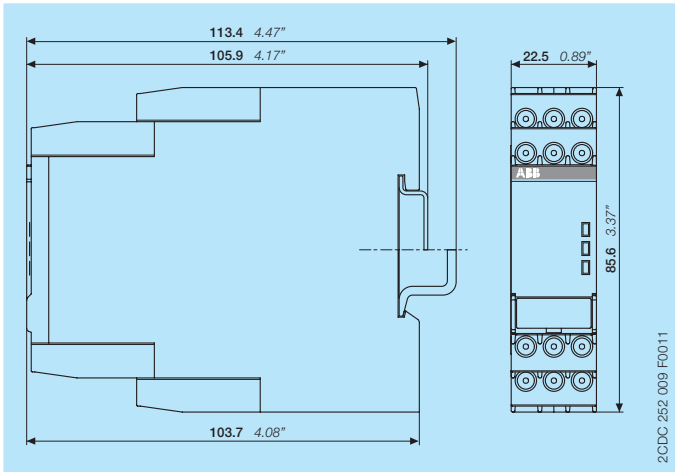

Accessories

in **mm** and *inches*

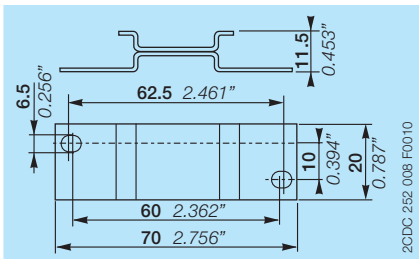

ADP.01 - Adapter for screw mounting

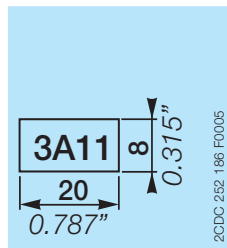

MAR.01 - Marker label for devices without DIP switches

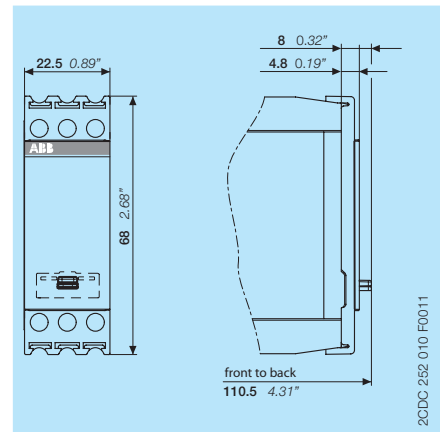

COV.11 - Sealable transparent cover

Further documentation

Document title	Document type	Document number
Electronic products and relays	Technical catalogue	2CDC 110 004 C020x
CM-PAS, CM-PFS, CM-PSS, CM-PVS	Instruction manual	1SVC 730 510 M0000

You can find the documentation on the internet at www.abb.com/lowvoltage -> Control Products -> Electronic Relays and Controls -> Three Phase Monitors.

Contact us

ABB STOTZ-KONTAKT GmbH

P. O. Box 10 16 80
69006 Heidelberg, Germany
Phone: +49 (0) 6221 7 01-0
Fax: +49 (0) 6221 7 01-13 25
E-mail: info.desto@de.abb.com

You can find the address of your
local sales organisation on the
ABB home page
<http://www.abb.com/contacts>
-> Low Voltage Products and Systems

Note:

We reserve the right to make technical changes or modify the contents of this document without prior notice. With regard to purchase orders, the agreed particulars shall prevail. ABB AG does not accept any responsibility whatsoever for potential errors or possible lack of information in this document.

We reserve all rights in this document and in the subject matter and illustrations contained therein. Any reproduction, disclosure to third parties or utilization of its contents – in whole or in parts – is forbidden without prior written consent of ABB AG.

Copyright© 2012 ABB
All rights reserved